



rambler™ **TTL**

ELECTRIC BIKE



OWNER'S MANUAL

**Read and understand this entire manual before using this product!
For assistance contact Razor.
DO NOT RETURN TO STORE.**

**NOTE: Manual illustrations are for demonstration purposes only.
Illustrations may not reflect exact appearance of actual product.
Specifications subject to change without notice.**

**Please have your product along with the 19 character product I.D. code with you
before contacting Razor for warranty assistance and/or replacement parts.**

Product I.D. Code: _____ - _____ - _____

CONTENTS

Safety Warnings.....	1-2	Usage.....	8-9
Minimum Leg Length.....	3	Repair and Maintenance.....	10-11
Before You Begin.....	3-4	Troubleshooting Guide.....	12-13
Assembly and Set-Up.....	4-6	Warranty.....	14
Charging the Battery.....	6	Contact Information.....	18
Pre-Ride Checklist.....	7		

INTRODUCTION: RAZOR RAMBLER TRL ADULT ELECTRIC BIKE

THE RAZOR RAMBLER TRL IS FOR ADULT USERS AND SHOULD ONLY BE RIDDEN CAREFULLY AND RESPONSIBLY BY APPROPRIATELY MATURE AND RESPONSIBLE RIDERS EXERCISING CAUTION AND RESPECTING APPLICABLE LAWS.

This product is not a toy for young riders! Razor emphasizes, therefore, the importance of riders to understand the risks associated with using literally any wheeled product around vehicle or pedestrian traffic and the specific risks of riding an electric bike. Bluntly put, you could get hurt and your actions could cause injury to others. You must be cautious, alert and take reasonable precautions to minimize such risks of falls, impacts or other problems.

The user must be, and is, responsible for determining whether local laws permit use of the Rambler TRL in varying circumstances (there is no “uniform Federal law” in existence to establish universal riding conditions). The rider must be, and is, responsible for acting maturely, carefully, and with respect for local rules of the road when riding, and the rider must be, and is, responsible for assessing and minimizing effects of potentially adverse riding conditions including darkness or impaired visibility, fog, rain, snow, hail, ice or electrical storms, which increase dangers inherent in operating any electric bike. The rider must be, and is, responsible for adjusting riding behavior and braking distance to suit the weather and traffic conditions, and also to recognize that riding in low visibility conditions decreases your ability to see and be seen, especially on public streets and around vehicles or pedestrians. The Razor Rambler TRL head- and tail-lights may reduce such risks, and riders also are encouraged to seek to enhance their visibility/conspicuity through use of higher visibility garments, lights or other reflective materials when riding in reduced visibility circumstances. Razor absolutely recommends that any rider wear a proper helmet to minimize potential head injuries.

Use of the Rambler TRL electric bike is recommended for mature riders – using age 18+ (the generally recognized age of “legal consent”) as a guide. Riders of the Rambler TRL certainly must respect and adhere to all locally applicable laws and rules applicable to the use of such products. And if you’re going to ride near cars, be legal and be safe!

SAFETY WARNINGS

⚠ WARNING: Riding a Rambler TRL does present potential risks and caution is required. Like any riding product, a Rambler TRL has inherent hazards associated with its use (for example, falling off or riding it into a hazardous situation). Like any riding product, the Rambler TRL can and is intended to move and it is therefore, of course, possible to lose control or otherwise get into dangerous situations. Riders must recognize that if such things occur, a rider can be seriously injured or die even when using safety equipment and other precautions. RIDE AT YOUR OWN RISK AND USE COMMON SENSE.

⚠ WARNING: Always check and obey any local laws or regulations which may affect the locations where the Rambler TRL electric bike may be used. Keeping away from cars and motor vehicle traffic provides the highest protection against risk of traffic-related injuries, of course.

The Rambler TRL is for mature riders seeking to operate this product safely in off-road conditions, or as legally permitted for safe use on roads for commuting applications, understanding that increased risks presented by traffic certainly emphasize that the need for caution, personal responsibility and compliance with local laws is imperative and is the rider’s responsibility. Only use where allowed and with caution.

Razor recommends that children under the age of 18 not be permitted to use this product. This recommendation is based not just on age or weight or height; it reflects consideration of expected maturity and skills as well as physical size. The recommended rider age of 18 years or older is only an estimate and can be affected by the rider’s size, weight, or skills – not every rider 18 years old or older will be suited to the product. Certainly, any rider unable to fit comfortably on the Rambler TRL should not attempt to ride it, but **a parent’s**

decision to allow his or her child to ride this product should be based on the child’s maturity, skill, and ability to follow rules. Razor emphasizes that adults are strongly advised not to disregard Razor’s recommendations or permit persons under the age of 18 to ride the Rambler TRL.

⚠ WARNING: NOT FOR RIDERS UNDER AGE 18 OR HEAVIER THAN 220 LB (100 KG). DO NOT EXCEED THE WEIGHT LIMIT OF 220 lb (100 kg) – including backpacks and other items that might be carried. Exceeding the weight limit could injure the rider and damage the Rambler TRL. Rider weight alone also does not necessarily mean a person’s size is appropriate to fit or maintain control of the Rambler TRL. Keep this product away from small children and remember that this product is not a toy and is intended for use only by persons who are, at a minimum, completely comfortable and competent while operating the product.

⚠ WARNING: PARENTAL AND ADULT RESPONSIBILITY AND SUPERVISION IS NECESSARY TO ASSURE USE BY MATURE RIDERS: Because products, like the Rambler TRL, can and do present potential hazards plainly associated with their use, it is well recognized THE NEED FOR EXERCISE OF PARENTAL RESPONSIBILITY IN SELECTING RIDING PRODUCTS APPROPRIATE TO THE AGE OF A CHILD, OR PARENTAL SUPERVISION IN SITUATIONS IN WHICH CHILDREN OF VARIOUS AGES MAY HAVE ACCESS TO THE SAME RIDING PRODUCTS, IS IMPORTANT. Not every product is appropriate for every age or size of child, and different age recommendations are found within this category of product which are intended to reflect the nature of the hazards and the expected mental or physical ability, or both, of a child to cope with the hazards.

SAFETY WARNINGS

Keep this product away from small children and remember that it is intended for use only by persons who are, at a minimum, completely comfortable and competent while operating the Rambler TRL.

Persons with any mental or physical conditions that may make them susceptible to injury, impair their physical dexterity or mental capabilities to recognize, understand, and follow safety instructions and to be able to understand the hazards inherent in the use of any ride-on product, should not use or be permitted to use products inappropriate for their abilities. Persons with heart conditions, head, back or neck ailments (or prior surgeries to these areas of the body), or pregnant women, should be cautioned not to operate the Rambler TRL.

DO NOT EXCEED THE WEIGHT LIMIT OF 220 lb (100 kg). Rider weight does not necessarily mean a person's size is appropriate to fit or maintain control of the Rambler TRL.

CHECK AND MAINTAIN PRODUCT CONDITIONS

Before use, check to confirm that covers and guards are in place and in serviceable condition. Check that the brakes and lights are functioning properly, that the tires are inflated properly and have sufficient tread remaining. The product should be maintained and repaired in accordance with the manufacturer's specifications, using only the manufacturer's authorized replacement parts, and should not be modified from the manufacturer's original design and configuration.

ACCEPTABLE RIDING PRACTICES AND CONDITIONS

Do not activate the throttle unless you are on the Rambler TRL and in a safe, outdoor environment suitable for riding. Once the throttle is activated the Rambler TRL will move forward.

The normal powered top speed of this product will be approximately 19.9 mph (32 km/h), which can be affected by conditions, such as rider weight, inclines and battery charge level. Avoid excessive speeds that can be associated with downhill rides.

Maintain a hold on the handlebars at all times. Do not touch the brakes or motor on your Rambler TRL when in use or immediately after riding, as these parts can become very hot.

Ride defensively. Watch out for potential obstacles that could catch your wheel or force you to swerve suddenly or lose control. Be careful to avoid pedestrians, skaters, skateboards, scooters, bikes, children or animals who may enter your path, and respect the rights and property of others.

The Rambler TRL is intended for use on flat, dry surfaces, such as pavement or level ground, without loose debris, such as sand, leaves, rocks or gravel. Wet, slick, bumpy, uneven or rough surfaces may impair traction and contribute to possible accidents. Do not ride your product in mud, ice, puddles or water. Watch out for potential obstacles that could catch your wheel or force you to swerve suddenly or lose control. Avoid sharp bumps, drainage grates, and sudden surface changes.

Do not attempt or do stunts or tricks on the Rambler TRL. The Rambler TRL is not made to withstand abuse from misuse, such as jumping, curb grinding or any other type of stunts. Racing, stunt riding, or other maneuvers also enhance risk of loss of control, or may cause uncontrolled rider actions or reactions.

Never allow more than one person at a time to ride the product.

Riding at night or when visibility is limited increases risks of accident or injury. Should the Rambler TRL be ridden in such conditions, use of lights and additional measures to increase rider visibility and Rambler TRL conspicuity are advised.

Never use near steps or swimming pools.

The Rambler TRL can operate more quietly than other motorized products may operate. Use care when in the vicinity of pedestrians or others who may have difficulty hearing your approach. Use handbell (not included) to sound warnings when appropriate.

Do not allow hands, feet, hair, body parts, clothing, or similar articles to come in contact with moving parts or wheels while the motor is engaged.

Do not touch electric motor or brakes when in use or immediately after riding.

Never use headphones or a cell phone to talk or text when riding.

Never ride your product while under the influence of drugs or alcohol.

Never hitch a ride with a vehicle.

PROPER RIDING ATTIRE

Always wear proper protective equipment, such as an approved safety helmet (with chin strap securely buckled), elbow pads, and kneepads. A helmet may be legally required by local law or regulation in your area. A long-sleeved shirt, and long pants are recommended. Always wear shoes and keep shoelaces tied and out of the way of the wheels and motor. Never ride barefooted or in sandals.

USING THE CHARGER

The charger supplied with the product should be regularly examined for damage to the cord, plug, enclosure and other parts. In the event of such damage, the product must not be charged until the charger has been repaired or replaced.

Use only with the recommended charger.

Use caution when charging.

The charger is not a toy. Charger should be operated by an adult.

Do not operate charger near flammable materials.

Unplug charger and disconnect from product when not in use.

Always disconnect from the charger prior to wiping down and cleaning your product with damp cloth.

IMPORTANT SAFETY INFORMATION

⚠ WARNING: When using this product, basic precautions should always be followed, including the following:

- Read all the instructions before using product.
- To reduce the risk of injury, close supervision is necessary when the product is used near children.
- Do not put fingers or hands into the product.
- Do not use this product if the flexible power cord or output cable is frayed, has broken insulation or an other signs of damage.

FAILURE TO USE COMMON SENSE AND HEED THE ABOVE WARNINGS FURTHER INCREASES RISK OF SERIOUS INJURY. USE AT YOUR OWN RISK AND WITH APPROPRIATE AND SERIOUS ATTENTION TO SAFE OPERATION. USE CAUTION.

Need Help? Visit our website for replacement parts, product support, a list of authorized service centers in the US and customer service contact information at www.razor.com. Please have the product I.D. code (located on the white label of your product) available for better assistance. Additional Customer Service contact information is listed at the back of this manual.

MINIMUM LEG LENGTH

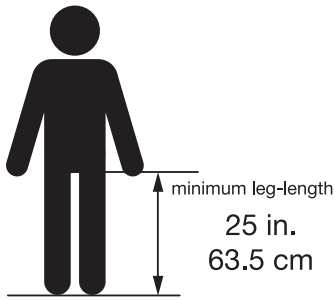

BEFORE YOU BEGIN

Remove contents from box. Remove the separators that protect the components from damage during shipping. Inspect the contents of the box for scratches in the paint, dents that may have occurred during shipping. Because your Rambler TRL was partially assembled and packed at the factory, there should not be any problems, even if the box has a few scars or dents.

MAKE SURE POWER BUTTON IS TURNED "OFF" BEFORE CONDUCTING ANY ASSEMBLY OR MAINTENANCE PROCEDURES.

Estimated Assembly and Set-Up Time

Razor recommends assembly by an adult.

Allow up to 15 minutes for assembly, not including initial charge time.

Allow up to 6 hours for charge (see page 6 for charging information).

WARNING:

DO NOT USE NON-RAZOR PARTS WITH YOUR RAZOR Rambler TRL. The Rambler TRL has been built to certain Razor design specifications. The original equipment supplied at the time of sale was selected on the basis of its compatibility with the frame and all other parts. Certain aftermarket components may not be compatible. Use of non-Razor parts will void the warranty.

Product ID Locations:
(See locations to the left)

1. Battery Cover
2. Frame
3. Charger
4. UPC Side of Box (Not Shown)

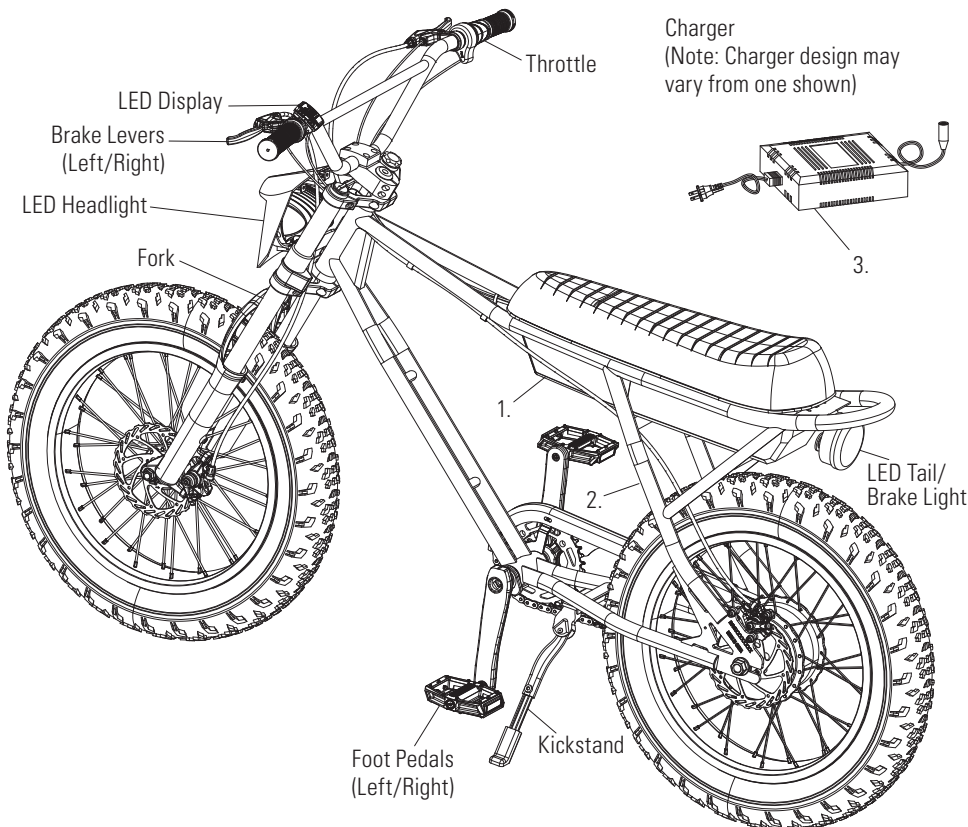

Need Help? Visit our website for replacement parts, product support, a list of authorized service centers in the US and customer service contact information at www.razor.com. Please have the product I.D. code (located on the white label of your product) available for better assistance. Additional Customer Service contact information is listed at the back of this manual.

BEFORE YOU BEGIN

Required Tools

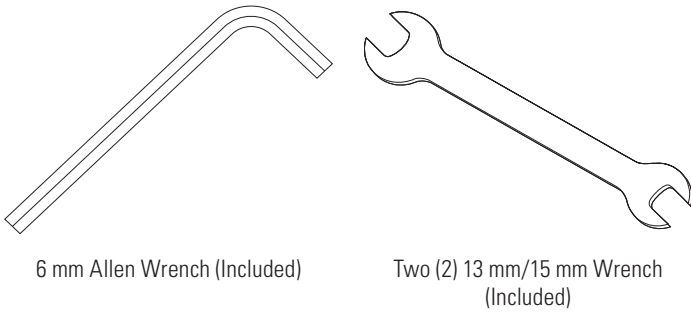

Box Contents:

- Rambler TRL
- Charger
- Owner's Manual
- Tools

ASSEMBLY AND SET-UP

Attaching the Handlebars

Required Tool: 6 mm Allen Wrench (included)

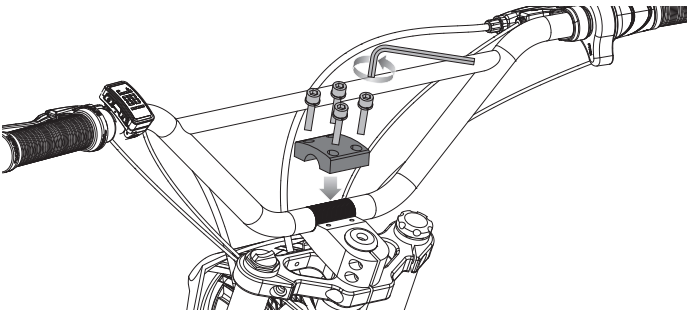

Place the handlebars in the handlebar clamps. Align parallel to the fork and tighten the bolts using a 6 mm Allen wrench. When properly tightened, the handlebars should not move forward or backward.

WARNING: Failure to properly tighten the handlebar clamps may allow the handlebars to dislodge while riding and may cause you to lose control and fall. When correctly tightened, the handlebars will not rotate out of alignment with the front wheel under normal circumstances.

Note: Make sure the brake cables/wires are out of the way before inserting the handlebar into the handlebar clamps.

Attaching the Front Wheel

Required Tools: Two (2) 15 mm Wrenches (included)

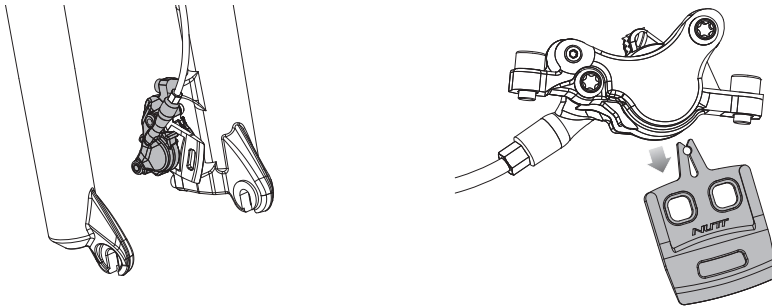

1 Locate the front brake pads in the lower tube on the left side of the front fork

2 Pull the spacer out of the brake pads

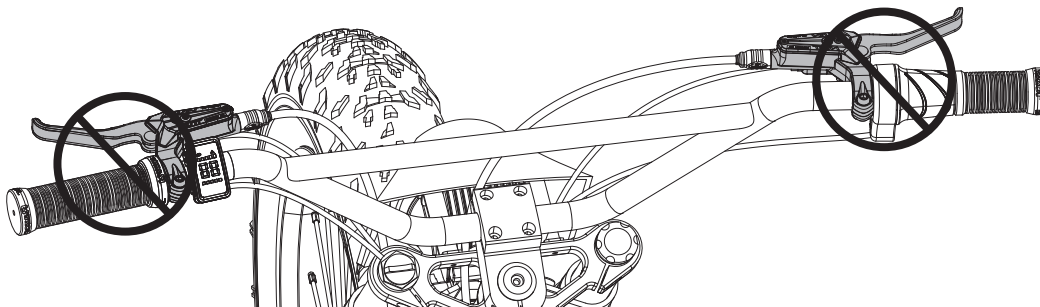

WARNING: Do not squeeze the brake levers when removing the spacer or before the wheel has been installed..

ASSEMBLY AND SET-UP

□ Attaching the Front Wheel

Required Tools: Two (2) 15 mm Wrenches (included)

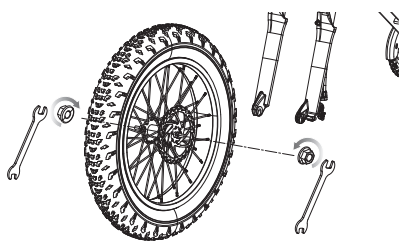

4 Remove the nuts on both sides of the front axle using a 15 mm wrench.

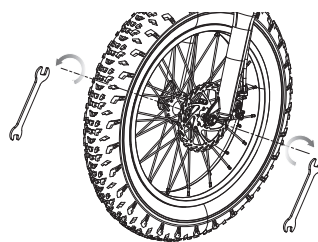

5 Install the wheel and tighten the nuts using a 15 mm wrench.

□ Attaching the Pedals

Required Tool: 15 mm Wrench (included)

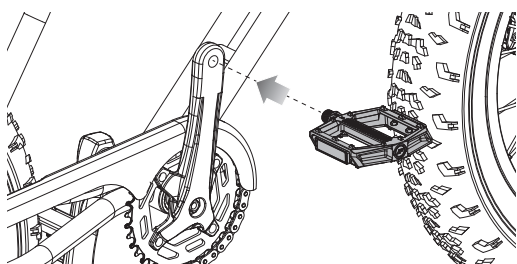

1 Align the hole in the RIGHT crank arm to insert the right pedal (marked "R").

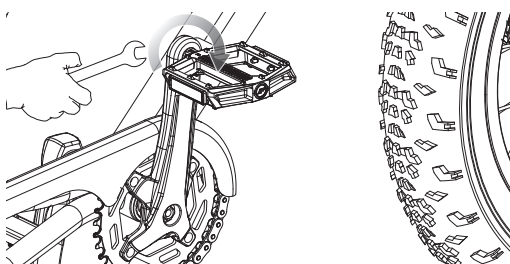

2 Use a 15 mm wrench to install the RIGHT pedal on the RIGHT crank arm (the chain side). To tighten, turn the axle clockwise. Tighten securely.

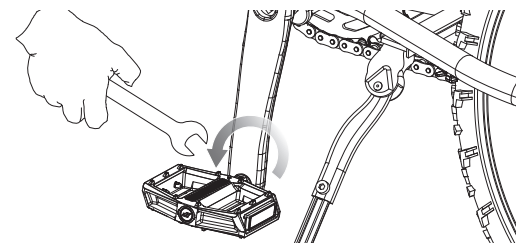

3 Repeat step 1 to insert the LEFT pedal (marked "L") into the LEFT crank arm. Use a 15 mm wrench to install LEFT pedal on LEFT crank arm.

Note: the LEFT pedal is a reverse thread. To tighten, you must turn the axle counterclockwise.

□ Adjusting the Front Fork

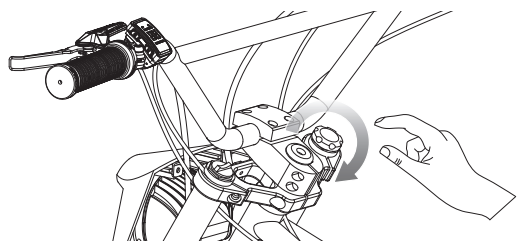

1 Turn the pressure adjustment knob on the right side of the front fork clockwise to stiffen the suspension. Rotating the knob to its limit will lock out the shock absorption function of the front fork.

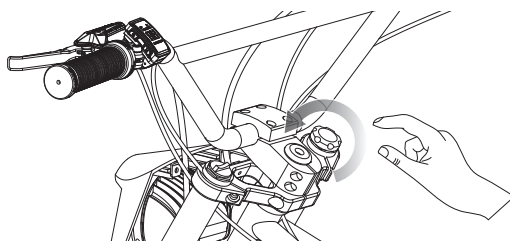

2 The shock absorption function of the front fork can be restored and softened by turning the pressure adjustment knob on the right side of the front fork counterclockwise.

Note: Feel of the shock can be tested by holding the front brake and pushing the handlebars down at the same time.

Need Help? Visit our website for replacement parts, product support, a list of authorized service centers in the US and customer service contact information at www.razor.com. Please have the product I.D. code (located on the white label of your product) available for better assistance. Additional Customer Service contact information is listed at the back of this manual.

ASSEMBLY AND SET-UP

□ Inflating the Tires

The tires are inflated when shipped, but they invariably may lose some pressure between the point of manufacturing and your purchase. **Always inflate tires to the correct PSI before first time use.**

Lower air pressure can result in a shorter ride time.

Periodically check tires. Reinflate when needed.

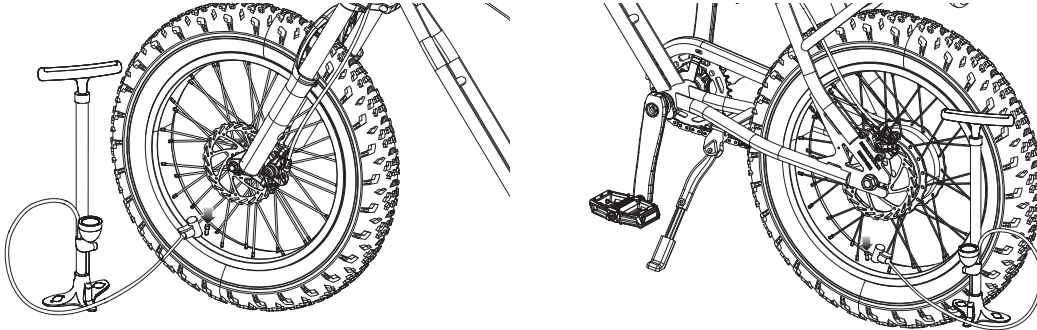

Remove the valve cap and using a bicycle style tire pump equipped for a Schrader-type valve, inflate the tires to the correct PSI indicated on the sidewall of the tires. Replace the valve cap.

⚠ WARNING: Do not use the Rambler TRL for the first time until you have inflated the tires to the correct PSI. Failure to do so may damage your Rambler TRL and void your warranty.

⚠ WARNING: Do not overinflate, as this could damage the tires or wheels.

Note: The pressure air supplies found at gasoline stations are designed to inflate high-volume automobile tires. If you decide to use such an air supply to inflate your Rambler TRL tires, first make sure the pressure gauge is working, then use very short bursts to inflate to the correct PSI. If you inadvertently overinflate the tires, release the excess pressure immediately.

CHARGING THE BATTERY

Your Rambler TRL may not have a fully charged battery; therefore you must charge the battery prior to use. Be sure to charge the battery in a clean, dry location away from direct sunlight, flames or sparks.

- Initial charge time: 6 hours.
- Recharge time: up to 6 hours, even if the light turns green. Recommended maximum charging time is 24 hours.
- Always charge the battery immediately after riding.
- Fully charge battery before storing for extended periods of time.
- Unplug charger from the wall outlet when not in use.
- Failure to recharge battery periodically may result in a battery that will not accept a charge.
- Make sure the power button is turned OFF when product is not in use. If the power button is left on for an extended period of time, the battery may reach a stage at which it will no longer hold a charge.
- Run time: Up to 50 minutes of continuous ride time. Run time may vary depending on riding conditions, rider weight, climate, and/or proper maintenance.
- Constant starting and stopping may shorten ride time.
- Battery life can vary depending on proper maintenance and usage of the product.
- Do not charge at or below 32°F (0°C).

⚠ WARNING: Use ONLY with the recommended charger. Batteries are only to be charged under adult supervision. The charger is not a toy. Always disconnect the charger before wiping down and/or cleaning the Rambler TRL with a damp cloth.

The charger supplied with the Rambler TRL should be regularly examined for damage to the cord, plug, enclosure and other parts. In the event of such damage, the Rambler TRL must not be charged until it has been repaired or replaced.

Chargers have built-in overcharge protection to prevent battery from being overcharged.

Note: If the charger gets warm during regular use, this is a normal response and is no cause for concern. If your charger does not get warm during use, it does not mean that it is not working properly.

Wall outlet - Green (stand by)
Wall outlet and unit - Red (charging)
Wall outlet and unit - Green (charged)

Note: Continue charging unit even if light turns green prior to 6 hours.

⚠ WARNING: Battery charge can deplete over time. Periodically recharge battery when not in use.

Charger

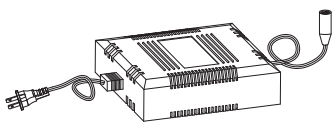

Charger

(Note: Charger design may vary from one shown)

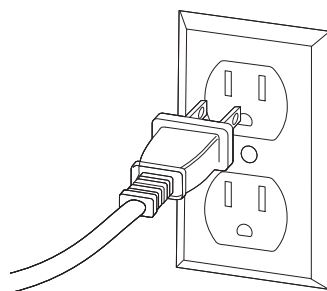

1 Plug the charger plug into wall outlet. The light on the charger should be green.

Note: If green light (LED) does not turn on, try a different outlet.

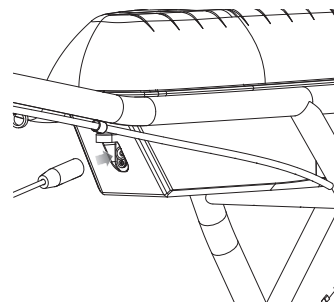

2 Note: Make sure power button is in the **OFF** position. Plug the charger into the charger port. The light on the charger should turn red during charging. The light will turn green again when charging is complete.

Model	Voltage (Nominal) Vdc	Capacity (Nominal) Ah	Charge Temperature Range	Operating Temperature Range
Rambler TRL	46.8	7.6	0° to 40°C 32° to 104°F	-20° to 40°C -4° to 122°F

Need Help? Visit our website for replacement parts, product support, a list of authorized service centers in the US and customer service contact information at www.razor.com. Please have the product I.D. code (located on the white label of your product) available for better assistance. Additional Customer Service contact information is listed at the back of this manual.

PRE-RIDE CHECKLIST



Lights

Check the head- and tail-lights for proper function. When you activate the lights (reference "Usage" on pages 8 and 9 of this manual), the headlight and taillight should illuminate.



Brakes

Check the brakes and brake light for proper function. When you squeeze the brake levers (on handlebar) the brakes should provide positive braking action and tail/brake light should illuminate. When you apply the brakes with the throttle on/engaged, the brake cut-off switch should cut power to the motor.



Wheels

Periodically inspect the wheels for excessive wear.



Tires

Periodically inspect the tires for excess wear and replace as needed. Regularly check the tire pressure and inflate as needed.



Frame, Fork and Handlebars

Check for cracks or broken connections. Although broken frames are rare, it is possible for an aggressive rider to run into a curb or object and wreck, bend or break a frame. Get in the habit of inspecting your Rambler TRL on a regular basis.



Hardware/Loose Parts

Before every ride, check all parts, such as nuts, bolts, fasteners, etc., to ensure they are secure and assembled correctly. There should not be any unusual rattles or sounds from loose parts or broken components. If the product is damaged, do not ride. **Reference "Safety Warnings" on pages 1 and 2 of this manual.**



Safety Gear

Always wear proper protective equipment, such as an approved safety helmet (with chin strap securely buckled), elbow pads, and kneepads. A helmet may be legally required by local law or regulation in your area. A long-sleeved shirt and long pants are recommended. Always wear shoes and keep shoelaces tied and out of the way of the wheels and drive system. **NEVER RIDE BAREFOOTED OR IN SANDALS.**



Laws and Regulations

Always check and obey any local laws or regulations.



Insurance

Do not assume that your existing insurance policies necessarily provide coverage for electric product use. Check with your insurance company for information regarding insurance.



Storage

Prolonged exposure to UV rays, rain and the elements may damage the enclosure materials, store indoors when not in use.

USAGE

□ How to Operate

Do not activate the twist-grip throttle unless you are on the Rambler TRL and in a safe, outdoor environment suitable for riding. The throttle can be activated as soon as the power button turns the product on.

□ How to Ride

Once you have inflated the tires (see page 6) and charged the battery (see page 6):

1. Put kickstand up.
2. Sit on the Rambler TRL with both feet on the ground on either side of the frame to balance the product.
3. Place both hands on the handlebars.
4. Turn power "ON" by pressing the power button **(A)** for two seconds. The display will light up.
5. Select speed mode. See page 9 for instructions.
6. The Rambler TRL default mode is the neutral mode. To activate the electric assist mode, toggle the display by pressing the top area of the display to change power level mode (see page 9).
7. Option 1 – Push off and pedal like a bicycle. Pedal assist function will activate automatically.
Option 2 - Twist the throttle **(B)** with right hand. Place feet on foot pedals once Rambler TRL is in motion.

Note: Keep both feet on the foot pedals while the Rambler TRL is in motion.

Headlight and Taillight: To activate the headlight and taillight the product must be powered **ON**. Press the light button **(C)** once to activate the headlight and taillight. To deactivate the headlight and taillight, press the light button once again.

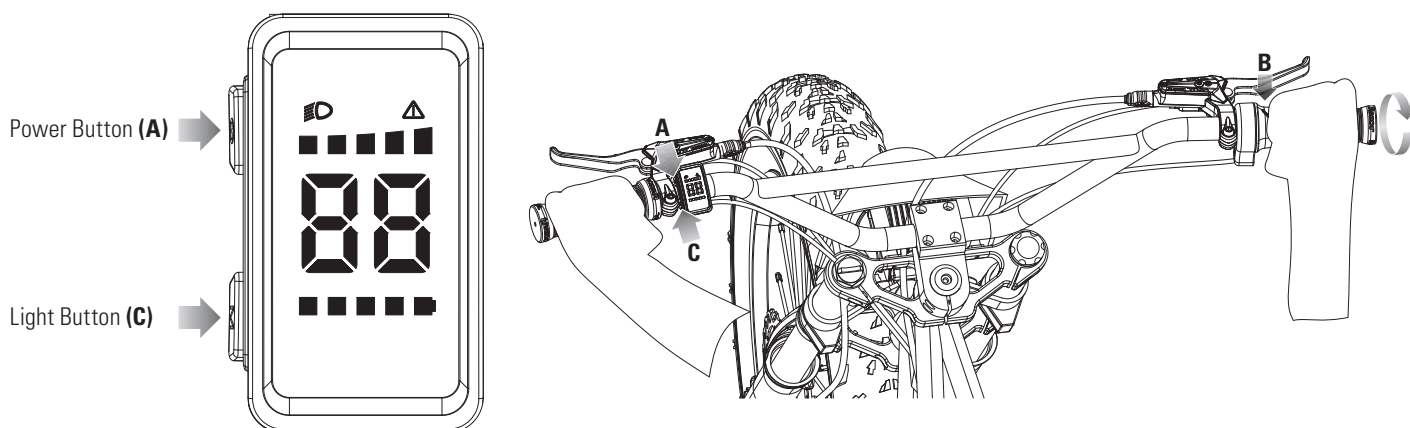

□ How to Use Electric Pedal Assist and Twist-Grip Throttle Features

The Rambler TRL is a Class 2 E Bike and can be powered by your choice of pedal assist or using the twist-grip throttle.

Electric Pedal Assist

Electric pedal assist will engage the motor and help you while you are pedaling. To engage electric pedal assist, start by switching to a power level mode by pressing the top area of the display to increase the power level (see page 9). When all the bars on the display are off, the Rambler TRL is at power level 0 (neutral). Start pedaling and the Rambler TRL will automatically activate the motor and assist you. As you increase the power level on the display, you can expect the electric bike to react with more power to assist you, ultimately resulting in higher speeds. When you stop pedaling or coast the electric pedal assist will also stop and wait for you to start pedaling again.

Throttle Assist

The electric assist feature can also be activated by utilizing the twist-grip throttle on the right-hand grip. When any power level is enabled on the display, the throttle is active and available to use at any time, including while you are pedaling. The throttle is variable speed and uses the full power range regardless of the power level setting on the display. Regulate your power and speed by adjusting how much you twist throttle. Using a combination of pedal assist and throttle assist can be helpful when quick bursts of power or speed are needed.

Need Help? Visit our website for replacement parts, product support, a list of authorized service centers in the US and customer service contact information at www.razor.com. Please have the product I.D. code (located on the white label of your product) available for better assistance. Additional Customer Service contact information is listed at the back of this manual.

USAGE

How to Stop

1. To stop, release the throttle (B) and apply the brakes, by squeezing the brake levers (D), until the product comes to a **complete stop**. When coming to a complete stop, place both feet on the ground to balance the Rambler TRL.
2. Make sure to turn the product **OFF** after your ride is complete. Pressing the power button (A) for two seconds will turn the product **OFF** completely.

Note: When the brakes are applied the tail/brake light will flash. The brake light is always functional and independent of the other lights being activated.

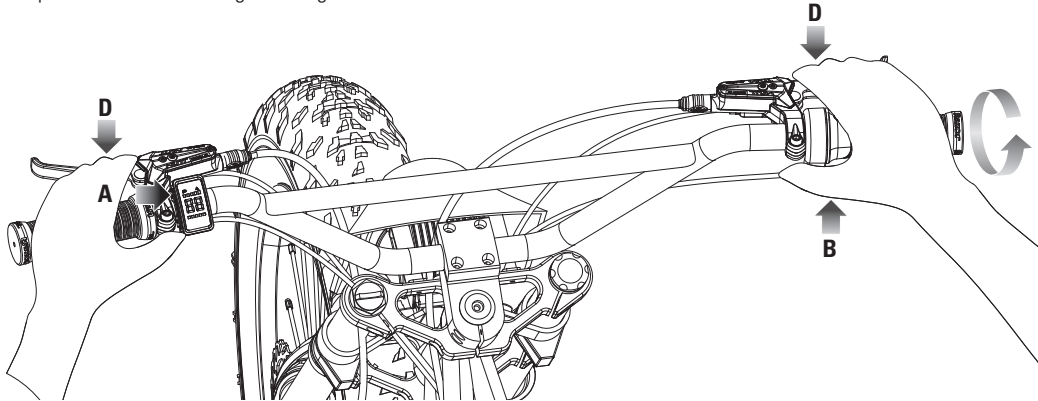

WARNING: The brake is capable of skidding the rear tire and throwing an unsuspecting rider. Practice in an open area free from obstacles until you are familiar with the brake function. Avoid skidding to a stop as this can cause you to lose control and/or damage the rear tire.

Note: As an additional safety feature, the Rambler TRL is designed to cut power to the motor when the hand brakes are applied.

Note: Practice riding only in wide open areas clear from curbs, parking blocks and other obstacles. Impacting the wheels against any hard surface can damage the wheels. Wheels are not covered under the limited warranty.

Note: The Rambler TRL features hydraulic brakes. The brakes will require periodic maintenance. Razor recommends brake maintenance by an experienced motorcycle or bicycle mechanic.

Note: Power level speeds can be affected by uphill climbs and rider weight; avoid excessive speeds that can be associated with downhill rides.

Changing the Power Level - Pedal Assist Mode

Power levels are controlled on the display. The display is activated when the power on the Rambler TRL is in the **ON** position. Practice in an open area free from obstacles until you are familiar with changing power levels. Riders can toggle power levels up or down while the Rambler TRL is in motion. Higher power levels can result in higher speeds and lower power levels will result in lower speeds. There are five (5) power levels. The Rambler TRL is set on power level 0 (neutral) setting at the factory.

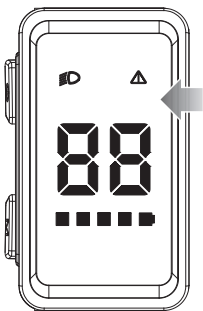

1 Each bar at the top of the display represents a power level. When all the bars are off, Rambler TRL is at power level 0 (neutral).

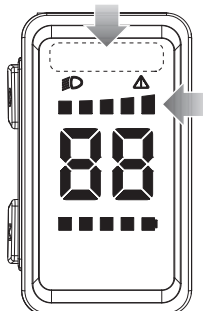

2 Press the top area of the display (as shown) to increase power levels in increments of one (1). Each time you press the top area of the display you will move to the next higher power level until you reach the maximum power level (5).

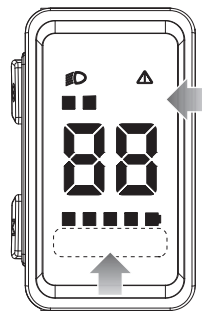

3 Press the bottom area of the display (as shown) to decrease power levels in increments of one (1). Each time you press the bottom area of the display you will move to the next lower power level until you reach the lowest power level (0)/neutral.

Note: Once the electric scooter is powered OFF, power levels are disabled. Power level will reset to level 0 (neutral) each time you power ON your electric scooter.

REPAIR AND MAINTENANCE

Turn power button "OFF" before beginning repair or maintenance:

- Read the instructions
- Remove charger plug
- Turn the power off
- Secure the product under repair
- Exercise caution around exposed parts
- Contact Razor customer service if unsure about any repair or maintenance
- Repair and maintenance should be performed by an adult only

❑ Replacing the Chain

Required Tools: Phillips Screwdriver and Needle Nose Pliers (not included)

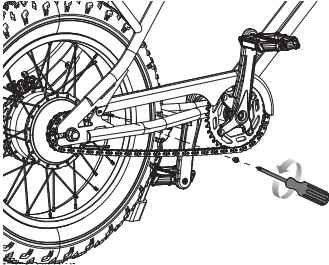

1 Using a Phillips screwdriver, remove the screws on the chain guard. Remove the chain guard and set aside.

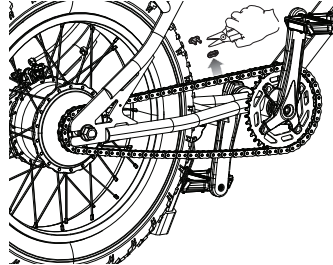

2 Find the master link on the chain and remove the clip with needle nose pliers to remove the old chain.

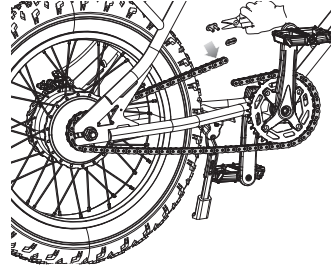

3 Thread the new chain through the frame, around the disc and freewheel. The new chain is secured by a clip for the master link.

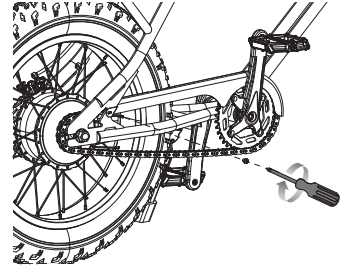

4 Install the chain guard and use a Phillips screwdriver to tighten the screws.

❑ Stem Assembly

Required Tools: 6 mm Allen Wrench, Phillips Screwdriver

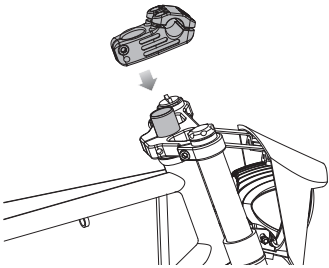

1 Align the stem fixing hole to the fork steering tube, put the stem to the fork tube, make sure the stem cover the fork top plate.

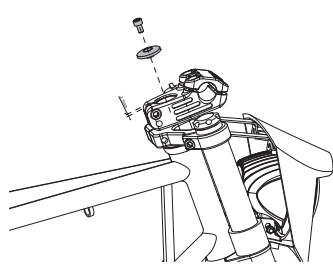

2 The top cover of the fork steering cover should cover the stem top side 2-3 mm.

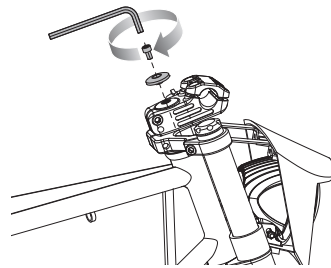

3 Prelock the stem top screw, about 5N-M or 44 in lbs.

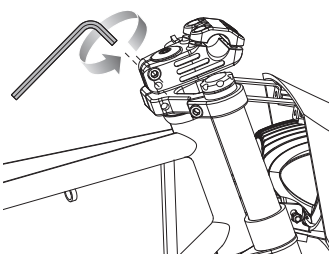

4 Install the chain guard and use a Phillips screwdriver to tighten the screws.

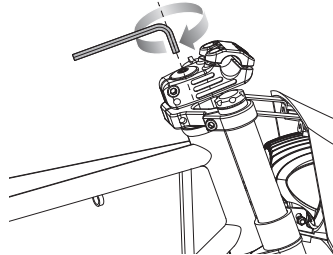

5 Tighten the stem top screw, about 6N-M or 53 in lbs

⚠ WARNING: Exercise care when adjusting the stem-to-fork assembly. Failure to properly follow the instructions may result in damage to the stem-to-fork assembly and may cause injury to the rider. Do not overtighten the stem bolt or other clamping device.

Need Help? Visit our website for replacement parts, product support, a list of authorized service centers in the US and customer service contact information at www.razor.com. Please have the product I.D. code (located on the white label of your product) available for better assistance. Additional Customer Service contact information is listed at the back of this manual.

REPAIR AND MAINTENANCE

⚠ WARNING: Risk of fire - no user serviceable electrical parts.

Cleaning Your Rambler TRL

Wipe with a damp cloth to remove dirt and dust. Do not use industrial cleaners or solvents as they may damage the surfaces. Do not use alcohol, alcohol-based or ammonia-based cleaners as they may damage or dissolve the plastic components or soften the decals or decal adhesive.

Battery Care and Disposal

Do not store in freezing or below freezing temperatures. To properly maintain your battery and ensure maximum battery life, carefully read the "Charging the Battery" section on page 6 of this owner's manual.



CONTAINS LITHIUM-ION BATTERY PACK. BATTERIES MUST BE RECYCLED.

Disposal: Your electric product uses a lithium-ion battery pack which must be recycled or disposed of in an environmentally safe manner. Do not dispose of a battery pack in a fire. The battery pack may explode.

Do not dispose of a battery pack in your regular household trash. The incineration, land filling or mixing of batteries with household trash is prohibited by law in most areas. Return exhausted batteries to a federal or state approved lithium-ion battery recycler.

Charger

The charger supplied with this product should be regularly examined for damage to the cord, plug, enclosure and other parts and in the event of such damage, the product must not be charged until it has been repaired or replaced.

Use ONLY with the recommended charger.

Not intended for use at elevations greater than 2000 m above sea level.

Wheels

Wheels and drive system are subject to normal wear and tear. It is the responsibility of the user to periodically inspect wheels for excess wear and replace hub motor components as required.

Replacement Parts

The most frequently requested replacement parts are available for purchase at some Razor retail partners. For the complete selection of replacement parts visit www.razor.com.

Repair Centers

For a list of authorized Razor repair centers:

- Check online at www.razor.com.
- Additional Customer Service contact information is listed on the back of this manual.

Recycling Lithium-ion

Batteries: Lithium-ion batteries are recyclable. You can help preserve our environment by returning your used rechargeable batteries to the collection and recycling location nearest you.



In the US and Canada only:

For more information regarding recycling of rechargeable batteries, call toll free 1-800-822-8837, or visit <http://www.call2recycle.org>

Caution: Do not handle damaged lithium-ion batteries.

Need Help? Visit our website for replacement parts, product support, a list of authorized service centers in the US and customer service contact information at www.razor.com. Please have the product I.D. code (located on the white label of your product) available for better assistance. Additional Customer Service contact information is listed at the back of this manual.

TROUBLESHOOTING GUIDE

*Product(s) should be turned **OFF** and fully charged prior to doing any Troubleshooting.

NOTE: All troubleshooting steps should be performed by an adult only.

Problem	Possible Cause	Solution
Does not work out of the box	Undercharged battery	Check lights on charger: Plugged into wall - Green Plugged into wall & unit - Red (charging) Plugged into wall & unit - Green (charging complete) No lights/Blinking lights - Replace charger
No longer works	No lights on charger	Check power to wall outlet and/or try a different outlet.
	Undercharged battery	Check lights on charger: Plugged into wall - Green Plugged into wall & unit - Red (charging) Plugged into wall & unit - Green (charging complete) No lights/Blinking lights - Replace charger
	Battery will not hold a charge	Replace battery.
Short run time/runs slow	Rider's weight	Do not exceed 220 lb (100 kg) maximum weight limit.
	Riding conditions	Use only on flat, dry surfaces. Avoid inclines and areas with heavy debris.
	Battery not fully charged	Charge product - refer to page 6 for charging information. Replace battery.
	Old/damaged battery	Charge battery at least once a month when not in use.
Product was running but suddenly stopped. Display is blank.	Battery high temperature protection.	Place the product in room temperature. When the battery temperature cools down enough, normal riding and display use can resume.
The light on the charger is green when attempting to charge product immediately after use, indicating that the product is not taking the charge.	Battery high temperature protection.	Place the product in room temperature. When the battery temperature cools down enough, normal charging can resume.

For more troubleshooting tips, a list of available replacement parts or to locate an authorized Service Center in your area, visit our website at www.razor.com or call toll free +1 866-467-2967 to speak to a live Customer Service Representative.

Need Help? Visit our website for replacement parts, product support, a list of authorized service centers in the US and customer service contact information at www.razor.com. Please have the product I.D. code (located on the white label of your product) available for better assistance. Additional Customer Service contact information is listed at the back of this manual.

TROUBLESHOOTING GUIDE

*Product(s) should be turned **OFF** and fully charged prior to doing any Troubleshooting.

NOTE: All troubleshooting steps should be performed by an adult only.

Display Error	Possible Cause	Solution	Note
21	Motor high temperature protection has been activated.	It may be necessary to wait for the motor to cool down.	
22	Throttle failure.	Check connections between the throttle and controller.	If connections are OK then throttle needs to be replaced.
23	Controller issue.	Check connectors between the motor and controller.	If connections are OK then motor or controller needs to be replaced. (controller replacement is most likely and motor replacement is less likely)
24	Motor issue.	Replace motor.	
30	Communication failure.	Check connectors between the display and controller.	If connections are OK then display needs to be replaced.

For more troubleshooting tips, a list of available replacement parts or to locate an authorized Service Center in your area, visit our website at www.razor.com or call toll free +1 866-467-2967 to speak to a live Customer Service Representative.

FCC COMPLIANCE

This device complies with Part 15 of the FCC Rules. Operation is subject to the following two conditions: (1) This device may not cause harmful interference, and (2) this device must accept any interference received, including interference that may cause undesired operation.

Note: This equipment has been tested and found to comply with the limits for a Class B digital device, pursuant to part 15 of the FCC Rules. These limits are designed to provide reasonable protection against harmful interference in a residential installation. This equipment generates, uses and can radiate radio frequency energy and, if not installed and used in accordance with the instructions, may cause harmful interference to radio communications. However, there is no guarantee that interference will not occur in a particular installation. If this equipment does cause harmful interference to radio or television reception, which can be determined by turning the equipment off and on, the user is encouraged to try to correct the interference by one or more of the following measures:

- Reorient or relocate the receiving antenna.
- Increase the separation between the equipment and receiver.
- Connect the equipment into an outlet on a circuit different from that to which the receiver is connected.
- Consult the dealer or an experienced radio/TV technician for help.

⚠ WARNING: Changes or modifications to this unit not expressly approved by Razor USA, could void the user's authority to operate the equipment.

WARRANTY

Razor Limited Warranty

The manufacturer warrants this product to be free of manufacturing defects for a period of 90 days from date of purchase. This Limited Warranty does not cover normal wear and tear, tire, tube or cables, or any damage, failure or loss caused by improper assembly, maintenance, storage or use of the Rambler TRL.

This Limited Warranty will be void if the product is ever:

- used in a manner other than for recreation or transportation;
- modified in any way;
- rented.

The manufacturer is not liable for incidental or consequential loss or damage due directly or indirectly to the use of this product.

Razor does not offer an extended warranty. If you have purchased an extended warranty, it must be honored by the store at which it was purchased.

For your records, save your original sales receipt with this manual and write the serial number below.

NOTICE: INSURANCE
YOUR INSURANCE POLICIES MAY NOT PROVIDE COVERAGE FOR
ACCIDENTS INVOLVING THE USE OF THIS SCOOTER/ELECTRIC
RIDE-ON PRODUCT. TO DETERMINE IF COVERAGE IS PROVIDED,
YOU SHOULD CONTACT YOUR INSURANCE COMPANY OR AGENT.

CUSTOMER SERVICE CONTACT INFORMATION

Need Help? Visit our website for product support, a list of authorized service centers in the US and customer service contact information at www.razor.com. Please have the product I.D. code (located on the white label of your product) available for better assistance. Additional Customer Service contact information is listed below:

AMERICAS

Razor USA LLC
P.O. Box 3610
Cerritos, CA 90703
USA

+1 866 467 2967
Monday - Friday
8:00 AM - 5:00 PM Pacific Time
customersupport@razorusa.com

EUROPE, MIDDLE EAST, AFRICA

Razor USA LLC (Europe)
Handelsweg 2
2742 RD Waddinxveen
Netherlands

+44 (0) 120 267 2702
info@razoreu.com

ASIA

Razor USA LLC (Asia)
P.O. Box 3610
Cerritos, CA 90703
USA

+81 50 7579 6622
info@razor-asia.com

UNITED KINGDOM AND IRELAND

Razor USA LLC (UK)
Unit 20
Hartnoll Business Centre
Post Hill, Tiverton
Devon EX16 4NG
UK

+44 (0) 120 267 2702
info@razoreu.com

AUSTRALIA AND NEW ZEALAND:

Razor USA LLC
P.O. Box 4280
Auburn South
VIC 3122
Australia

+1 800 954 354 (AU)
+0 800 003 221 (NZ)
info@razoranz.com

IMPORTED IN JAPAN BY B-PLUS ASIA CORP.

Razor USA LLC
THE RIRSTIK COMPANY
Kurokawa 3-1, Asaoku,
Kawasaki, Kanagawa
215-0035 JAPAN

+81 (0) 44 328 9057 Tel
+81 (0) 44 328 9067 Fax
info@razor-asia.com

Printed in China for Razor USA LLC.

Copyright © 2003-2023 Razor USA, LLC. All rights reserved. Razor® and the Razor logo design are among the registered trademarks of Razor USA LLC in the United States and/or select foreign countries. Rambler™ and the Rambler TRL logo design are trademarks of Razor USA LLC.