



PARTY POP

TEKNO™
KICK SCOOTER

SCOOTERS



OWNER'S MANUAL

Read and understand this entire manual before allowing child to use this product! For assistance contact Razor. DO NOT RETURN TO STORE.

NOTE: Manual illustrations are for demonstration purposes only. Illustrations may not reflect exact appearance of actual product. Specifications subject to change without notice.

Please have your product along with the 22 character product I.D. code with you before contacting Razor for warranty assistance and/or replacement parts.

Product I.D. Code: _____ - _____ - _____

CONTENTS

| | | | |
|--------------------------|---|---------------------------------------|---|
| Safety Warnings..... | 1 | Usage..... | 4 |
| Before You Begin..... | 2 | Repair and Maintenance..... | 5 |
| Assembly and Set-Up..... | 3 | Product Parts..... | 6 |
| Pre-Ride Checklist..... | 4 | Warranty and Contact Information..... | 7 |

SAFETY WARNINGS

⚠ AN IMPORTANT MESSAGE TO PARENTS: This manual contains important information. For your child's safety, initial setup and steering tube installation require adult assistance for young riders. It is your responsibility to review this information with your child and make sure that your child understands all warnings, cautions, instructions and safety topics. Razor USA recommends that you periodically review and reinforce the information in this manual with younger riders, and that you inspect and maintain your child's scooter to ensure their safety.

⚠ GENERAL WARNING: Scooter riding can be a hazardous activity. Scooters can and are intended to move, and it is therefore possible to get into dangerous situations and/or lose control and/or fall. If such things occur you can be seriously injured or die. **LIKE ANY OTHER MOVING PRODUCT, USING A SCOOTER CAN BE A DANGEROUS ACTIVITY AND MAY RESULT IN INJURY OR DEATH EVEN WHEN USED WITH PROPER SAFETY PRECAUTIONS. USE AT YOUR OWN RISK AND USE COMMON SENSE.**

Always wear safety equipment, such as helmet, knee pads and elbow pads. Always wear a helmet when riding your scooter and keep the chinstrap securely buckled.

Always wear closed toe shoes.

Ride on smooth, paved surfaces away from motor vehicles.

Avoid sharp bumps, drainage grates, and sudden surface changes. Scooter may suddenly stop.

Avoid streets and surfaces with water, sand, gravel, dirt, leaves, and other debris. Wet weather impairs traction, braking, and visibility.

Do not ride at night or in low visibility conditions.

Brake will get hot from continuous use. Do not touch after braking.

Avoid excessive speed associated with downhill rides.

Obey all local traffic and scootering laws and regulations.

Watch out for pedestrians.

Do not exceed 143 lb (65 kg) total weight on the scooter.

Do not allow children under age six (6) to use the scooter. These scooters are for children ages six (6) and above. Children under age eight (8) should ride with adult supervision at all times. All children and preteens should ride with adult guidance at all times.

Rider weight does not necessarily mean a child's size is appropriate to fit or maintain control of the scooter.

A parent's decision to allow his or her child to ride this product should be based on the child's maturity, skill and ability to follow rules.

ACCEPTABLE RIDING PRACTICES AND CONDITIONS

Direct parental supervision is required. Scooters are meant to be used only in controlled environments free of potential traffic hazards and not on public streets. Do not allow your child to ride a scooter in any areas where vehicle traffic is present. Child must maintain a hold on the handlebars at all times. Never allow more than one child at a time to ride a scooter. Never use near steps, sloped driveways, hills, roadways, alleys or swimming pool areas.

Do not ride a scooter in wet weather. Scooters are intended for use on solid, flat, clean and dry surfaces, such as pavement or level ground, without loose debris, such as rocks or gravel. Wet, slick or uneven and rough surfaces may impair traction and contribute to possible accidents. Do not ride a scooter in mud, ice, puddles or water. Avoid excessive speeds that can be associated with downhill rides. Never risk damaging surfaces, such as carpet or flooring, by use of a scooter indoors. Do not ride at night or when visibility is impaired.

PROPER RIDING ATTIRE

Always ensure child is wearing proper protective equipment, such as an approved safety helmet. A helmet may be legally required by local law or regulation in your area. A child should always wear shoes and keep shoelaces tied and out of the way of the wheels. Never ride barefooted or in sandals. Knee pads and elbow pads are recommended.

⚠ WARNING: ALWAYS INSPECT SCOOTER PRIOR TO RIDING. Properly inspecting and maintaining your scooter can reduce the risk of injury. Always inspect your scooter before riding and regularly maintain it.

⚠ WARNING: CHECK LOCAL LAWS REGARDING SCOOTER USE. Check local laws and regulations to see where and how you may use your Razor scooter legally. In many states and local areas scooter riders are required BY LAW to wear a helmet. Check local laws and regulations regarding laws governing helmet use and scooter operation in your area.

⚠ WARNING: AAA BATTERIES
This product contains AAA batteries. A swallowed AAA battery can cause internal chemical burns. Dispose of used batteries immediately. Keep new and used batteries away from children. If you think batteries might have been swallowed or placed inside any part of the body, seek immediate medical attention.

Batteries included for lights - adult attention for changing and disposal.

Battery should only be replaced by an adult.

Loose battery could present a choking hazard and should be kept away from small children.

Dispose of batteries properly.

FAILURE TO USE COMMON SENSE AND HEED THE ABOVE WARNINGS FURTHER INCREASES RISK OF SERIOUS INJURY. USE AT YOUR OWN RISK AND WITH APPROPRIATE AND SERIOUS ATTENTION TO SAFE OPERATION. USE CAUTION.

BEFORE YOU BEGIN

Remove contents from box. Inspect the contents of the box for scratches in the paint and/or dents that may have occurred during shipping. Because your scooter was partially assembled and packed at the factory, there should not be any problems, even if the box has a few scars or dents.

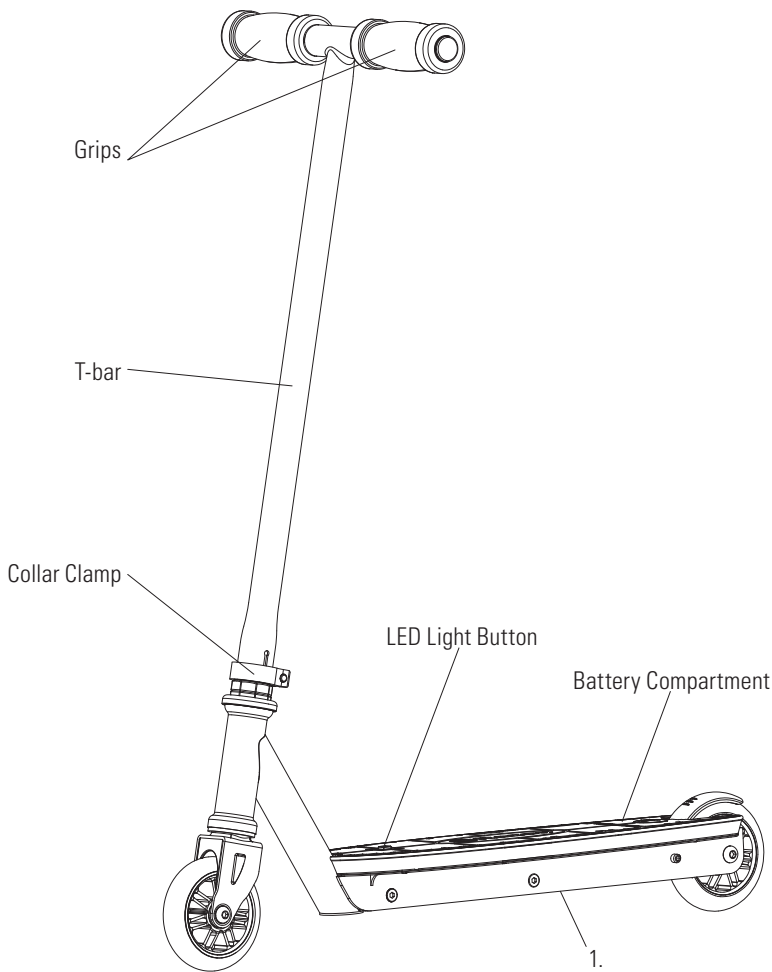

Required Tool

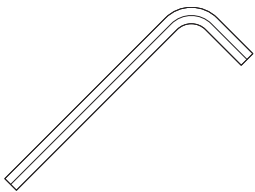

5 mm Allen Wrench (included)

⚠ WARNING: DO NOT USE NON-RAZOR PRODUCTS WITH YOUR SCOOTER. Razor scooters have been built to certain Razor design specifications. The original equipment supplied at the time of sale was selected on the basis of its compatibility with the frame, fork and all other parts. Certain aftermarket products may not be compatible and will void the warranty.

Product ID Locations:

(See locations to the left)

1. Deck (Underneath Unit)
2. Box - Side of UPC (Not Shown)

Box Contents:

- Scooter
- Allen Wrench
- Owner's Manual

Need Help? Visit our website for replacement parts, product support, a list of authorized service centers in the US and customer service contact information at www.razor.com. Please have the product I.D. code (located on the white label of your product) available for better assistance. Additional Customer Service contact information is listed at the back of this manual.

ASSEMBLY AND SET-UP

□ Handlebar Assembly

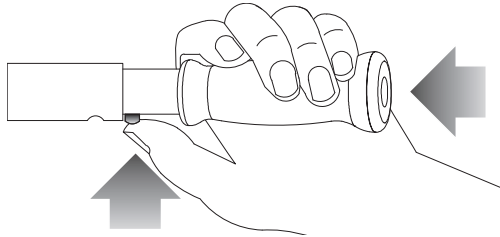
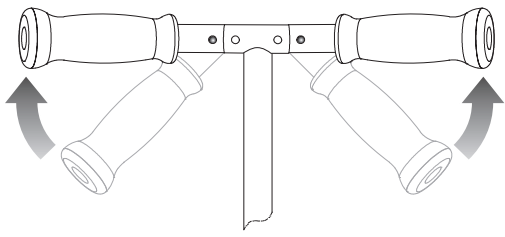

1 Insert and secure the left and right handlebars by pressing the spring-loaded buttons and inserting them into the T-bar.

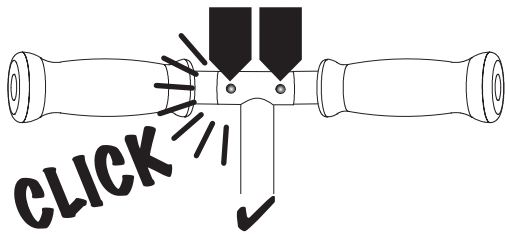

2 Make certain BOTH handlebars are properly locked onto the T-bar.

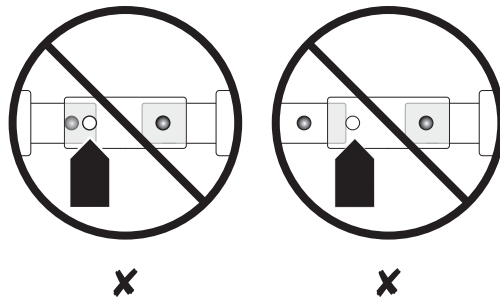

⚠ WARNING: Failure to properly engage the spring-loaded buttons may cause the handlebars to dislodge while riding and may cause rider to lose control and fall. When correctly engaged, the handlebars will not rotate nor move sideways, and the spring-loaded buttons will be clearly visible in the holes on the T-bar.

⚠ WARNING: Check hand grips regularly for wear or damage, as grips are designed to aid in gripping handlebars and to provide some protection against possible impact. Replace immediately if worn, torn, damaged or missing.

□ T-bar Assembly

Required Tool: 5 mm Allen Wrench (included)

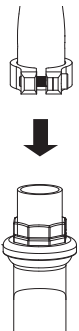

1 Loosen the collar clamp and slide it upward. Insert T-bar into the fork until it bottoms out on the headset locknut.

Note: If necessary, carefully twist the T-bar side to side while pushing downward until T-bar bottoms out on the headset locknut.

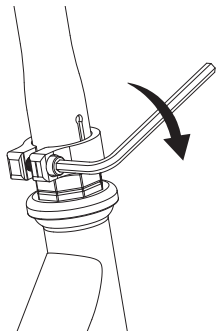

2 With the front wheel pointed straight ahead, the handlebars square to the front wheel and the Razor logo facing the front, tighten the clamp as shown. Tighten securely.

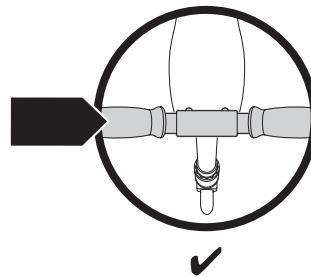
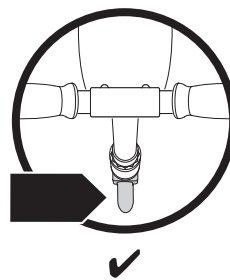

⚠ WARNING: Failure to properly install and tighten the pivoting mechanism and the plastic cover may cause the rider to lose control and fall. If you do not understand these instructions, contact Razor customer care for assistance.

⚠ WARNING: Do not attempt to thread the handlebar into the front fork thread. Tighten clamp securely.

□ Activating the Batteries

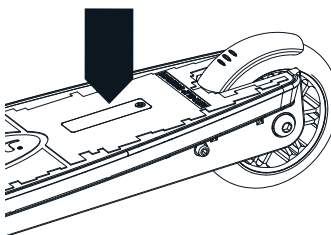

1 To activate the batteries, locate the battery compartment on the top of the deck and remove the plastic tab from under the battery cover.

PRE-RIDE CHECKLIST



Deck and Handlebars

Check for cracks or broken connections. Although broken decks are rare, it is possible for an aggressive rider to run into a curb or object and wreck and bend or break the deck. Get in the habit of inspecting your scooter on a regular basis.



Hardware/Loose Parts

Check and secure all fasteners before every ride. Make sure the collar clamp is locked properly into place before riding. There should not be any unusual rattles or sounds from loose parts or broken components. If the unit is damaged, do not ride. **Reference "Safety Warnings" on page 1 of this manual.**



Safety Gear

Always wear proper protective gear, such as an approved safety helmet. Elbow pads and kneepads are recommended. Always wear closed toe shoes (lace-up with rubber soles) and keep shoelaces tied and out of the way of the wheels. **NEVER RIDE BAREFOOTED OR IN SANDALS.**



Laws and Regulations

Always check and obey any local laws or regulations.



Be Careful!

This product is not for aggressive or trick riding. Avoid steep inclines and don't ride too fast — you can lose control and fall. Skateboard parks are not designed for young riders. Never ride in traffic or on the street and watch your surroundings for pedestrians, bikers, boarders and skaters.

Maintain a hold on the handlebars at all times.

USAGE

How to Ride

Place one foot on the baseboard and push forward with the other foot. Steer with both hands on the handlebars. For enhanced cornering, lean slightly into the direction of the turn.

Gently step on the LED light button to activate the LED lights. Lights will remain on for approximately 20 seconds after button has been released. Gently step on the LED light button again to re-activate the lights.

How to Stop

For controlled stops, apply the brake by stepping on the brake. Razor recommends that you practice applying the brake at various speeds and in an open area free from obstructions before riding your Razor scooter around others.

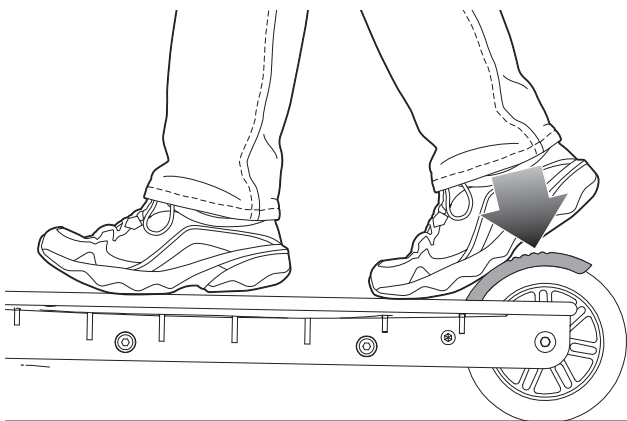

Need Help? Visit our website for replacement parts, product support, a list of authorized service centers in the US and customer service contact information at www.razor.com. Please have the product I.D. code (located on the white label of your product) available for better assistance. Additional Customer Service contact information is listed at the back of this manual.

REPAIR AND MAINTENANCE

□ Cleaning

Wipe with a damp cloth to remove dirt and dust. Do not use industrial cleaners or solvents, as they may damage the surfaces. Do not use alcohol, alcohol-based or ammonia-based cleaners, as they may damage or dissolve the plastic components or soften the decals or decal adhesive.

□ Collar Clamp

Required Tool: 5 mm Allen Wrench (included)

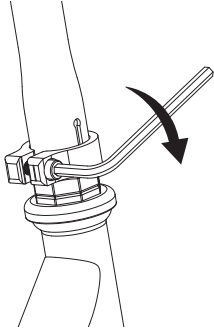

1 Using a 5 mm Allen wrench, check that the collar clamp bolt is tightened securely. Make sure the front wheel is pointed straight ahead and the handlebars is squared to the front wheel.

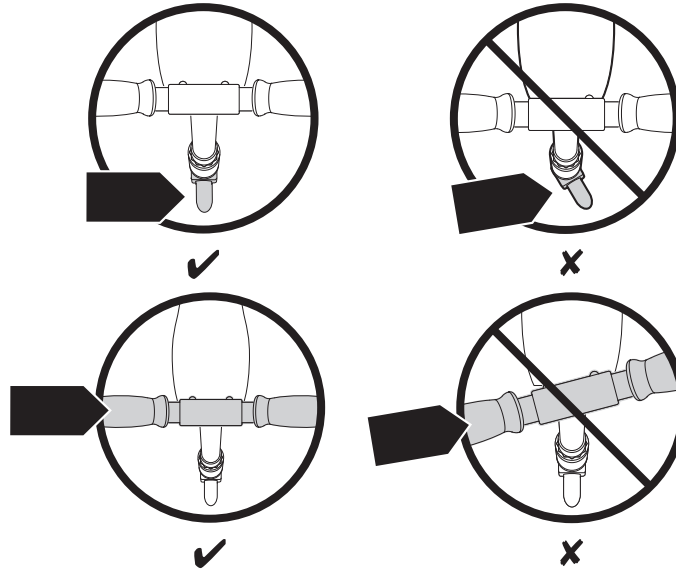

□ Replacing the Batteries

Required Tool: Phillips screwdriver (not included)

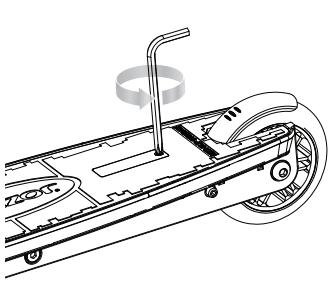

1 Remove the battery cover.

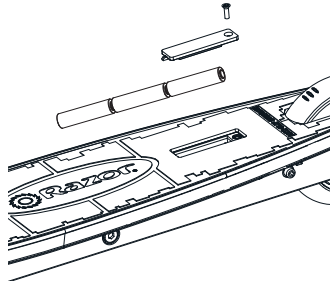

2 Discard the old batteries and replace with three (3) AAA batteries.

Note: Make sure to install **ALL** batteries positive (+) side facing the rear of the scooter.

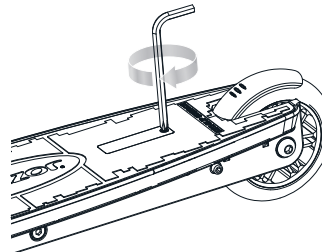

3 Replace battery cover and tighten the screw.

□ Wheels and Bearings

Under normal circumstances and conditions, Razor wheels and wheel bearings are maintenance free. Nonetheless, it is the responsibility of the owner or guardian to periodically inspect the wheels for wear and tear, the axle for proper tightness, bearings for side-to-side play, and for loose parts. When a wheel develops play, this is an indication of excess wear and replacement is necessary. Replace immediately with only genuine Razor wheels. Worn wheels/bearings are considered normal wear-and-tear and are not covered by the Razor Warranty. Wheels other than genuine Razor wheels may not be compatible with your Razor scooter. The use of anything other than genuine Razor replacement parts may affect your safety and will void your warranty.

□ Replacement Parts

The most frequently requested replacement parts are available for purchase at some Razor retail partners. For the complete selection of replacement parts visit www.razor.com.

□ Repair Centers

For a list of authorized Razor repair centers:

- Check online at www.razor.com.
- Additional Customer Service contact information is listed at the back of this manual.

⚠ WARNING:

- AAA batteries included for lights - adult attention for changing and disposal.
- Batteries should only be replaced by an adult.
- Loose batteries could present a choking hazard and should be kept away from small children.
- Do not mix old and new batteries.
- Do not mix alkaline, standard (carbon-zinc) or rechargeable (ni-cad, ni-mh, etc.) batteries.
- Dispose of batteries properly.

Note: Batteries are not covered under the Limited Warranty.

⚠ WARNING: Wheelies and other stunt-type riding reduces your ability to maneuver and control your scooter. Take the necessary precautions, such as wearing appropriate protective gear, and practice in an area safe for stunt riding and free from obstructions.

PRODUCT PARTS

Keep your scooter running for years with genuine Razor parts. Visit our website for more information on spare part availability. (Illustrations may not reflect exact appearance of actual product. Specifications subject to change without notice.)

- | | | | |
|--------------------|--------------------------|---|---|
| 1. Handlebars | 4. Collar Clamp | 7. Wheels (Front/Rear) 7-1 Axle Bolts (Front/Rear) | 10. Batteries AAA (x3) |
| 2. Handlebar Grips | 5. Headset (Upper/Lower) | 8. Brake | 11. Deck Plate w/ LED Lights 11-1 LED Light Button |
| 3. T-Bar | 6. Front Fork | 9. Battery Cover | |

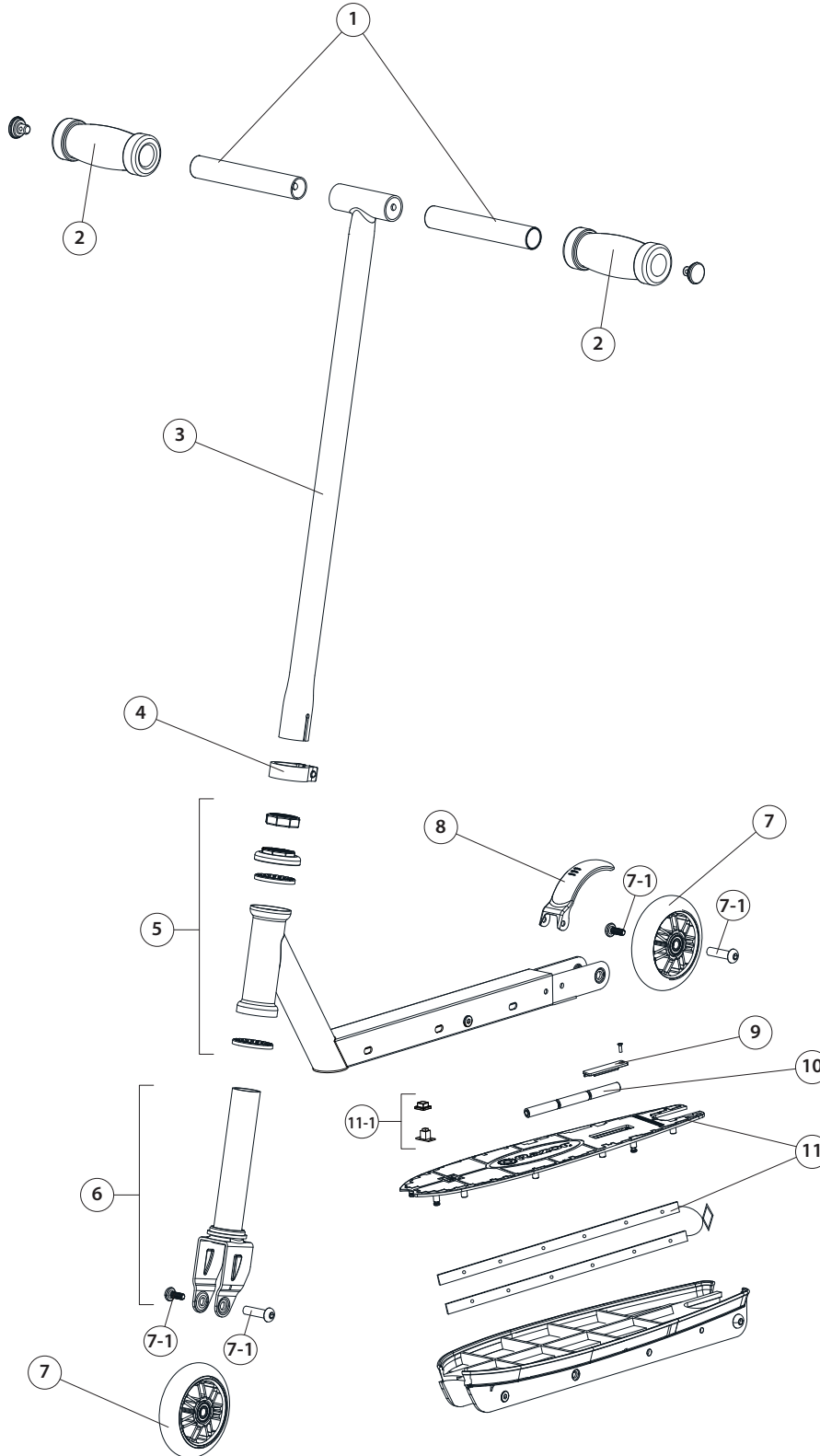

Need Help? Visit our website for replacement parts, product support, a list of authorized service centers in the US and customer service contact information at www.razor.com. Please have the product I.D. code (located on the white label of your product) available for better assistance. Additional Customer Service contact information is listed at the back of this manual.

WARRANTY

Razor Limited Warranty

The manufacturer warrants this product to be free of manufacturing defects for a period of 6 months from date of purchase. This Limited Warranty does not cover normal wear and tear, or any damage, failure or loss caused by improper assembly, maintenance, or storage.

This Limited Warranty will be void if the product is ever:

- used in a manner other than for recreation;
- modified in any way;
- rented.

The manufacturer is not liable for incidental or consequential loss or damage due directly or indirectly to the use of this product.

Razor does not offer an extended warranty. If you have purchased an extended warranty, it must be honored by the store at which it was purchased.

For your records, save your original sales receipt with this manual and write the serial number below.

CUSTOMER SERVICE CONTACT INFORMATION

Need Help? Visit our website for product support, a list of authorized service centers in the US and customer service contact information at www.razor.com. Please have the product I.D. code (located on the white label of your product) available for better assistance. Additional Customer Service contact information is listed below:

AMERICAS

Razor USA LLC
P.O. Box 3610
Cerritos, CA 90703
USA

+1 866 467 2967
Monday - Friday
8:00 AM - 5:00 PM Pacific Time
customersupport@razorusa.com

EUROPE, MIDDLE EAST, AFRICA

Razor USA LLC (Europe)
Handelsweg 2
2742 RD Waddinxveen
Netherlands

+44 (0) 120 267 2702
info@razoreu.com

ASIA

Razor USA LLC (Asia)
P.O. Box 3610
Cerritos, CA 90703
USA

+81 50 7579 6622
info@razor-asia.com

UNITED KINGDOM AND IRELAND

Razor USA LLC (UK)
Unit 20
Hartnoll Business Centre
Post Hill, Tiverton
Devon EX16 4NG
UK

+44 (0) 120 267 2702
info@razoreu.com

AUSTRALIA AND NEW ZEALAND

Razor USA LLC (AU and NZ)
P.O. Box 4280
Auburn South VIC 3122,
Australia

+1 800 954 354 (AU)
+0 800 003 221 (NZ)
info@razoranz.com

Printed in China for Razor USA LLC.

Copyright © 2003-2021 Razor USA LLC. All rights reserved. Razor® and the Razor logo design are among the registered trademarks of Razor USA LLC and/or its affiliated companies in the United States and/or select foreign countries. PartyPop™, Tekno™, the Party Pop logo design and the Tekno logo design are trademarks of Razor USA LLC and/or its affiliated companies in the United States and/or selected foreign countries.

US_210410